

N-channel MOSFET

## Features

- Low gate charge
- 100% avalanche tested
- Improved dv/dt capability
- RoHS compliant
- Halogen free package
- JEDEC Qualification

$BV_{DSS}$	$I_D$	$R_{DS(on)MAX}$
250V	8A	<0.6Ω

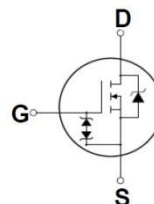
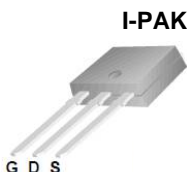

Device	Package	Marking	Remark
TMD8N25Z/TMU8N25Z	D-PAK/I-PAK	TMD8N25Z/TMU8N25Z	RoHS
TMD8N25ZG/TMU8N25ZG	D-PAK/I-PAK	TMD8N25ZG/TMU8N25ZG	Halogen Free

## Absolute Maximum Ratings

Parameter	Symbol	TMD8N25Z(G)/TMU8N25Z(G)	Unit
Drain-Source Voltage	$V_{DSS}$	250	V
Gate-Source Voltage	$V_{GS}$	±30	V
Continuous Drain Current	$I_D$	$T_C = 25\text{ }^\circ\text{C}$	8
		$T_C = 100\text{ }^\circ\text{C}$	3.6
Pulsed Drain Current <sup>(Note 1)</sup>	$I_{DM}$	32	A
Single Pulse Avalanche Energy <sup>(Note 2)</sup>	$E_{AS}$	147	mJ
Repetitive Avalanche Current <sup>(Note 1)</sup>	$I_{AR}$	8	A
Repetitive Avalanche Energy <sup>(Note 1)</sup>	$E_{AR}$	5.2	mJ
Power Dissipation	$P_D$	$T_C = 25\text{ }^\circ\text{C}$	52
		Derate above 25 °C	0.41
Peak Diode Recovery dv/dt <sup>(Note 3)</sup>	dv/dt	4.5	V/ns
Operating Junction and Storage Temperature Range	$T_J, T_{STG}$	-55~150	°C
Maximum lead temperature for soldering purposes, 1/8" from case for 5 seconds	$T_L$	300	°C

\* Limited only by maximum junction temperature

## Thermal Characteristics

Parameter	Symbol	TMD8N25Z(G)/TMU8N25Z(G)	Unit
Maximum Thermal resistance, Junction-to-Case	$R_{\theta JC}$	2.4	°C/W
Maximum Thermal resistance, Junction-to-Ambient	$R_{\theta JA}$	110	°C/W

**Electrical Characteristics :  $T_C=25^\circ\text{C}$ , unless otherwise noted**

Parameter	Symbol	Test condition	Min	Typ	Max	Units
<b>OFF</b>						
Drain-Source Breakdown Voltage	$BV_{DSS}$	$V_{GS} = 0\text{ V}, I_D = 250\ \mu\text{A}$	250	--	--	V
Zero Gate Voltage Drain Current	$I_{DSS}$	$V_{DS} = 250\text{ V}, V_{GS} = 0\text{ V}$	--	--	1	$\mu\text{A}$
		$V_{DS} = 200\text{ V}, T_C = 125^\circ\text{C}$	--	--	10	$\mu\text{A}$
Forward Gate-Source Leakage Current	$I_{GSSF}$	$V_{GS} = 30\text{ V}, V_{DS} = 0\text{ V}$	--	--	100	$\mu\text{A}$
Reverse Gate-Source Leakage Current	$I_{GSSR}$	$V_{GS} = -30\text{ V}, V_{DS} = 0\text{ V}$	--	--	-100	$\mu\text{A}$

**ON**

Gate Threshold Voltage	$V_{GS(th)}$	$V_{DS} = V_{GS}, I_D = 250\ \mu\text{A}$	3	--	5	V
Drain-Source On-Resistance	$R_{DS(on)}$	$V_{GS} = 10\text{ V}, I_D = 4\text{ A}$	--	0.5	0.6	$\Omega$
Forward Transconductance <sup>(Note 4)</sup>	$g_{FS}$	$V_{DS} = 30\text{ V}, I_D = 4\text{ A}$	--	7.5	--	S

**DYNAMIC**

Input Capacitance	$C_{iss}$	$V_{DS} = 25\text{ V}, V_{GS} = 0\text{ V},$ $f = 1.0\text{ MHz}$	--	423	--	pF
Output Capacitance	$C_{oss}$		--	74	--	pF
Reverse Transfer Capacitance	$C_{rss}$		--	12	--	pF

**SWITCHING**

Turn-On Delay Time <sup>(Note 4,5)</sup>	$t_{d(on)}$	$V_{DD} = 125\text{ V}, I_D = 8\text{ A},$ $R_G = 25\ \Omega$	--	14	--	ns
Turn-On Rise Time <sup>(Note 4,5)</sup>	$T_r$		--	25	--	ns
Turn-Off Delay Time <sup>(Note 4,5)</sup>	$t_{d(off)}$		--	30	--	ns
Turn-Off Fall Time <sup>(Note 4,5)</sup>	$T_f$		--	14	--	ns
Total Gate Charge <sup>(Note 4,5)</sup>	$Q_g$	$V_{DS} = 200\text{ V}, I_D = 8\text{ A},$ $V_{GS} = 10\text{ V}$	--	8.4	--	nC
Gate-Source Charge <sup>(Note 4,5)</sup>	$Q_{gs}$		--	1.9	--	nC
Gate-Drain Charge <sup>(Note 4,5)</sup>	$Q_{gd}$		--	4	--	nC

**SOURCE DRAIN DIODE**

Maximum Continuous Drain-Source Diode Forward Current	$I_S$	----	--	--	8	A
Maximum Pulsed Drain-Source Diode Forward Current	$I_{SM}$	----	--	--	32	A
Drain-Source Diode Forward Voltage	$V_{SD}$	$V_{GS} = 0\text{ V}, I_S = 8\text{ A}$	--	--	1.5	V
Reverse Recovery Time <sup>(Note 4)</sup>	$t_{rr}$	$V_{GS} = 0\text{ V}, I_S = 8\text{ A}$	--	157	--	ns
Reverse Recovery Charge <sup>(Note 4)</sup>	$Q_{rr}$	$di_F / dt = 100\text{ A}/\mu\text{s}$	--	0.6	--	$\mu\text{C}$

Note :

1. Repeated rating : Pulse width limited by safe operating area
2.  $L=3.68\text{mH}, I_{AS} = 8\text{ A}, V_{DD} = 50\text{ V}, R_G = 25\ \Omega,$  Starting  $T_J = 25^\circ\text{C}$
3.  $I_{SD} \leq 8\text{ A}, di/dt \leq 200\text{ A}/\mu\text{s}, V_{DD} \leq BV_{DS},$  Starting  $T_J = 25^\circ\text{C}$
4. Pulse Test : Pulse width  $\leq 300\ \mu\text{s},$  Duty Cycle  $\leq 2\%$
5. Essentially Independent of Operating Temperature Typical Characteristics

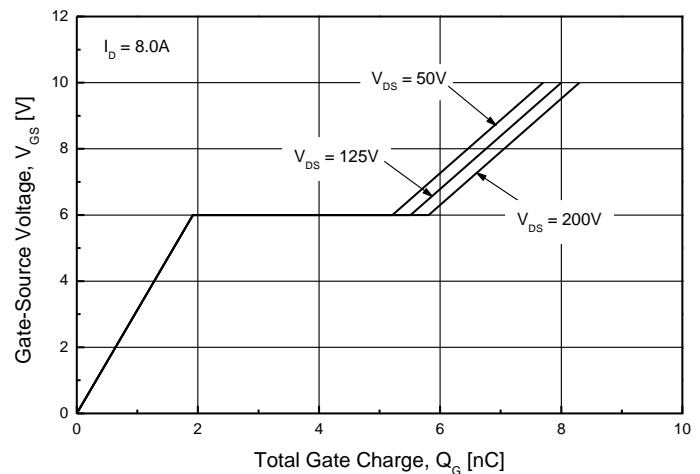
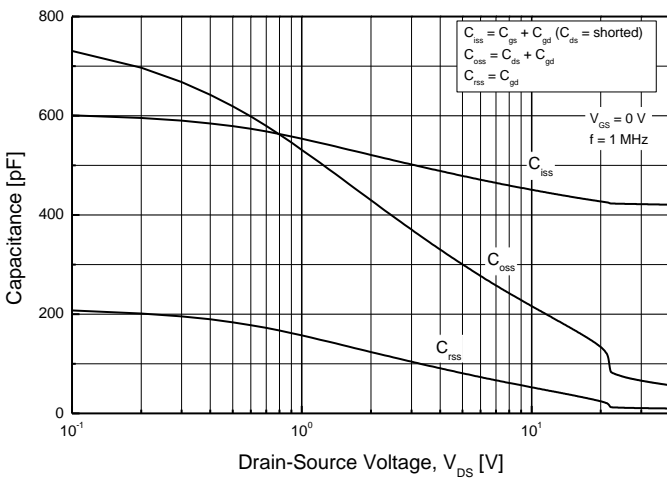
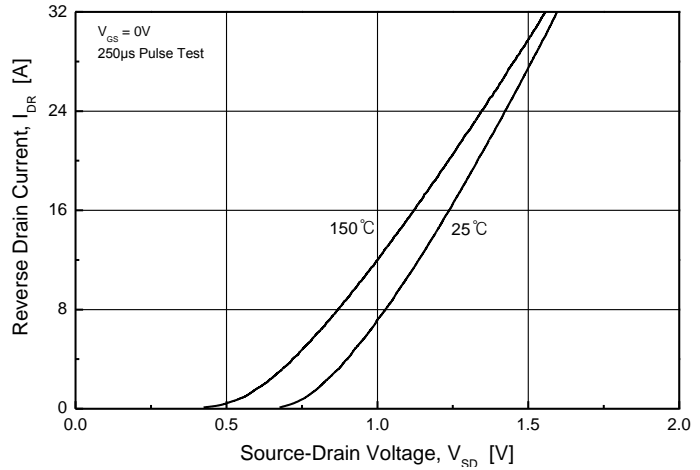
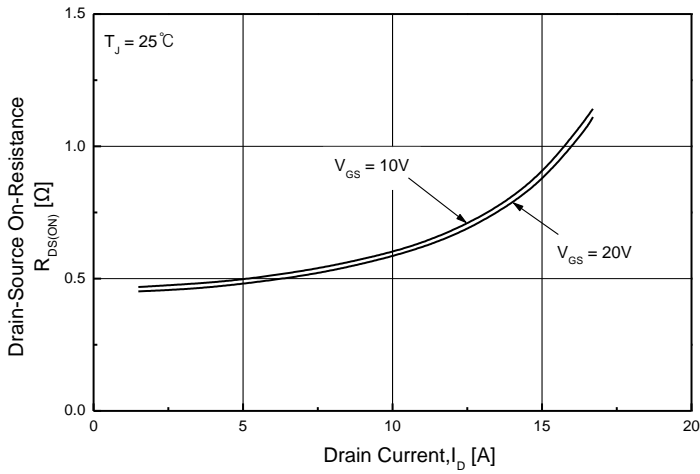
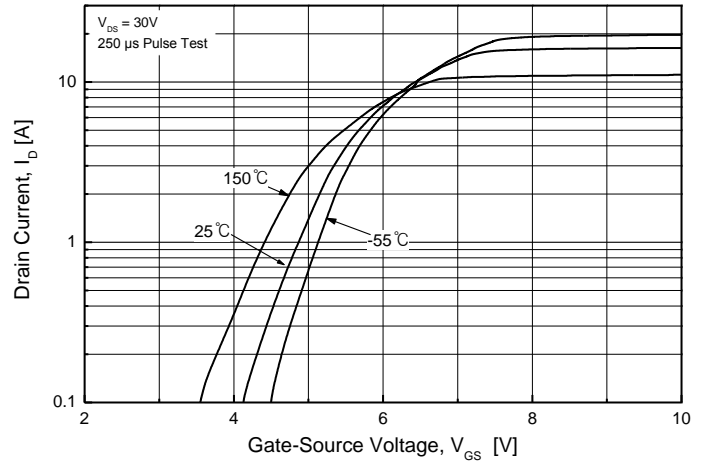
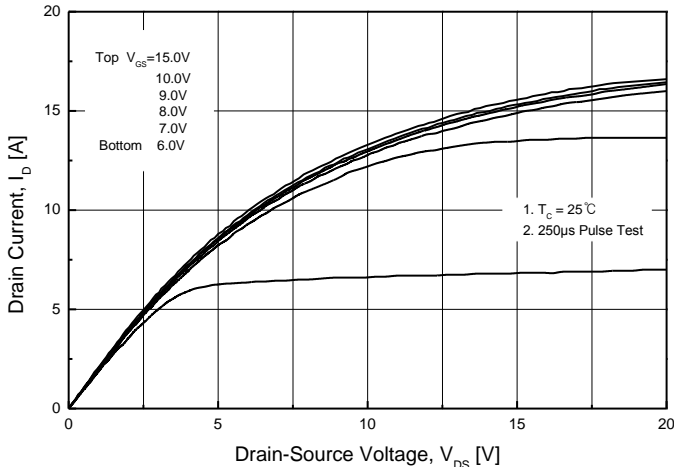

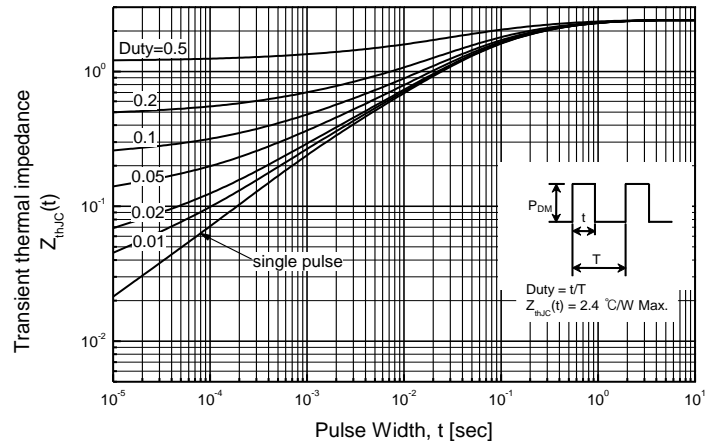
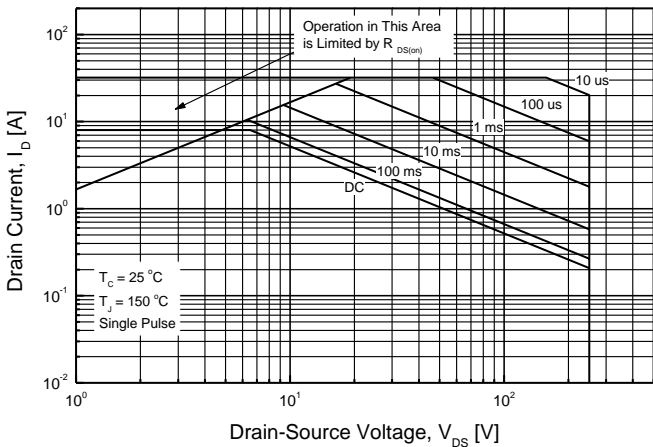
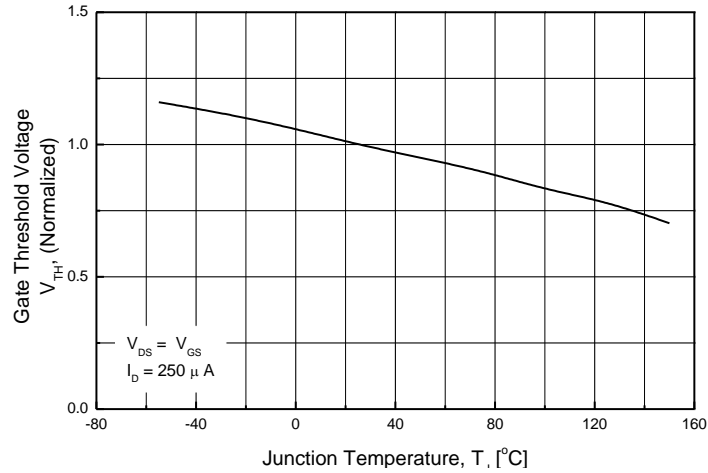
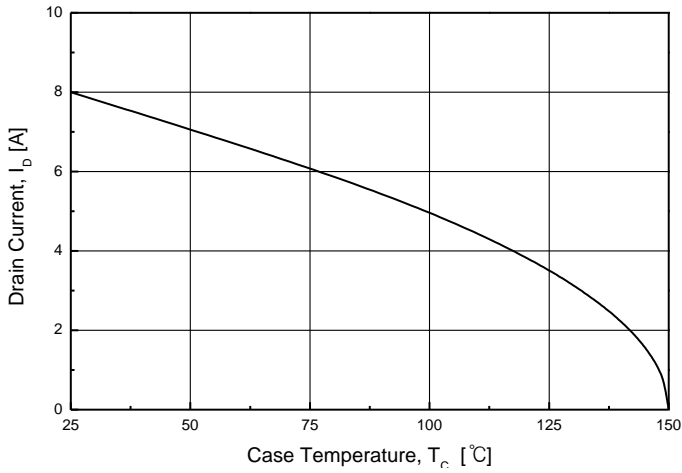
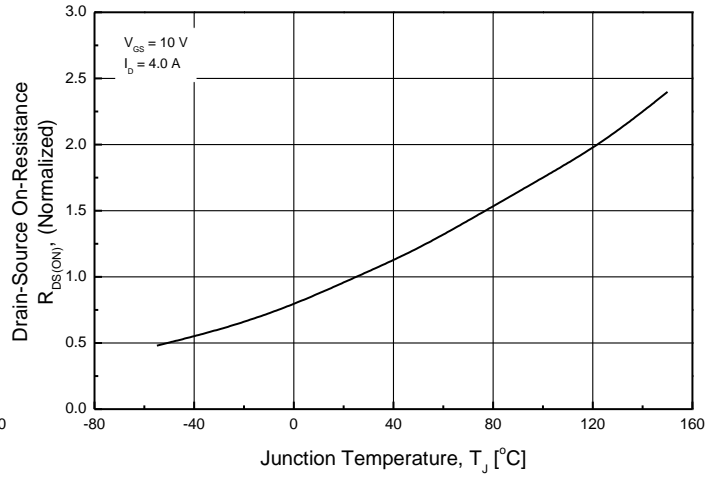
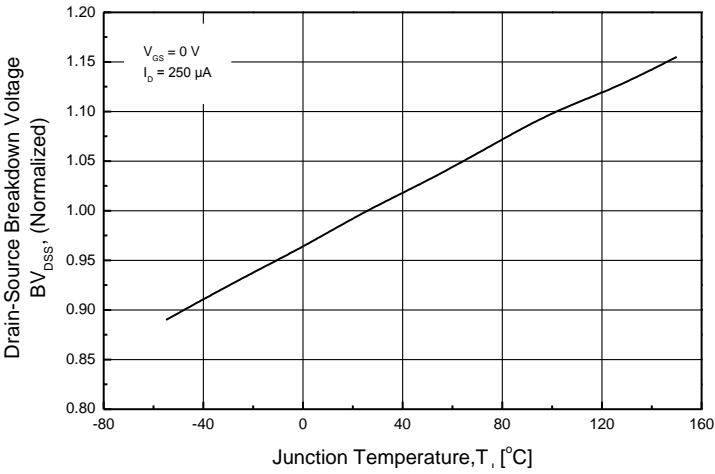

**TO-252 (D-PAK) MECHANICAL DATA**

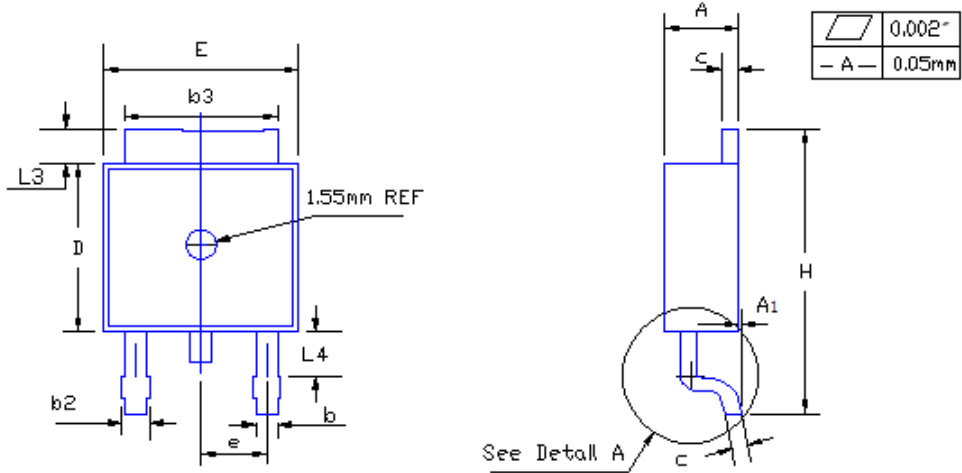

SYMBOL	MILLIMETERS	
	MIN	MAX
A	2.19	2.38
A1	—	0.13
b	0.64	0.89
b2	0.84	1.14
b3	5.21	5.46
c	0.46	0.61
D	5.97	6.22
D1	5.21	—
E	6.35	6.73
E1	4.83	—
e	2.29BSC	
H	9.65	10.41
L	1.40	1.78
L2	0.51BSC	
L3	0.89	1.27
L4	0.64	1.01
Ø	0	8

**TO-251 (I-PAK) MECHANICAL DATA**



SYMBOL	MILLIMETERS	
	MIN	MAX
A	2.19	2.38
A1	1.04	1.23
b	0.64	0.89
b1	0.84	1.14
b2	5.23	5.48
c	0.46	0.61
D	5.91	6.28
E	6.21	6.59
e	2.28 TYP	
L	8.89	9.65
L2	0.89	1.27